

1 STEPHANIE OSLER HASTINGS (State Bar No. 186716)
2 MACKENZIE W. CARLSON (State Bar No. 323850)
3 BROWNSTEIN HYATT FARBER SCHRECK, LLP
4 1021 Anacapa Street, 2nd Floor
5 Santa Barbara, CA 93101-2711
6 Telephone: 805.963.7000
7 Email: SHastings@bhfs.com

8 Attorneys for Plaintiff
9 GOLDEN STATE WATER COMPANY

10 SUPERIOR COURT OF THE STATE OF CALIFORNIA
11 FOR THE COUNTY OF RIVERSIDE

12 Coordination Proceeding Special Title
13 (Cal. Rules of Court, rule 3.550)

14 MOJAVE BASIN AREA WATER CASES

15 CITY OF BARSTOW, et al.,

16 Plaintiff,

17 v.

18 CITY OF ADELANTO, et al.,

19 Defendant.

JCCP NO.: 5265

Lead Case No. CIV 208568

Assigned for All Purposes to the
Honorable Harold W. Hopp, Dept. 1

**NOTICE OF LODGING OF
POWERPOINT PRESENTATION IN
SUPPORT OF GOLDEN STATE
WATER COMPANY'S MOTION TO
ENFORCE JUDGMENT**

Date: October 2, 2024

Time: 8:30 am

Dept.: 1

Reservation ID: 562595011427

1
2
3
4
5
6
7
8
9
10
11
12
13
14
15
16
17
18
19
20
21
22
23
24
25
26
27
28

TO ALL PARTIES AND THEIR ATTORNEYS OF RECORD:

PLEASE TAKE NOTICE THAT Golden State Water Company (“GSWC”) hereby lodges with this Court the following document in support of its Motion to Enforce Judgment (“Motion”) in accordance with the direction in the Court’s July 3, 2024 Order on the Watermaster’s Annual Motion to Adjust Free Production Allowance for Water Year 2024-2025:

1. A 17-page document entitled Expert Report of Anthony Brown Hydrologic Conditions and Water Flow Between the Alto Subarea (Alto) and Centro Subarea (Centro) of the Mojave Basin, San Bernardino County, California (the “Presentation”), which is the PowerPoint Presentation to be made by Mr. Anthony Brown, aquilogic, Inc., at the Court hearing on GSWC’s Motion on October 2, 2024.

A copy of the Presentation in PDF format is attached to this Notice as Exhibit A. Further, the native file of the PowerPoint Presentation will be delivered to the Court and served on the Parties shown on the attached Proof of Service.

Dated: September 26, 2024

BROWNSTEIN HYATT FARBER
SCHRECK, LLP



By: _____
STEPHANIE OSLER HASTINGS
MACKENZIE W. CARLSON
Attorneys for Plaintiff
GOLDEN STATE WATER COMPANY

EXHIBIT A

Anthony Brown, M.S.

Expert Witness - Hydrology

Hydrologic Conditions and Water Flow Between the Alto Subarea (Alto) and the Centro Subarea (Centro) of the Mojave Basin, San Bernadino County, California

October 2, 2024

GSWC 0988

Opinions

1. Production wells operated by Golden State in Centro are experiencing chronic water level declines. In simple terms, considering a conservation of mass, groundwater level declines (i.e., loss of storage) result from excessive discharge (e.g., over-pumping) and/or insufficient recharge (e.g., river seepage).
2. Based on currently available data and analyses performed by aquilogic, the observed chronic water level declines at Golden State's production wells in Centro do not result from over-pumping at the wells.
3. Thus, it is more likely that recharge to Centro from Alto has decreased and contributed to the observed chronic water level declines.

Opinions (continued)

4. There is currently a deficit in the volume of water producers in Alto are obligated under the Judgment to deliver as recharge to Centro.
5. The Watermaster should take actions to better quantify recharge to Centro, notably stream flows in the Mojave River and subsurface flow.
6. The Watermaster should also address recommendations presented below to ensure more effective management of groundwater in the Basin.

Statement of Problem

Groundwater levels recorded in Golden State's production wells in the Barstow area have been declining chronically over time

- Consistent average annual production from Golden State's production wells of 5,570 AFY over the last ten years
- Total average annual verified production for Centro of 17,773 AFY
- Significantly less than Watermaster's estimate of 32,000 AFY to 37,000 AFY of inflow to Centro

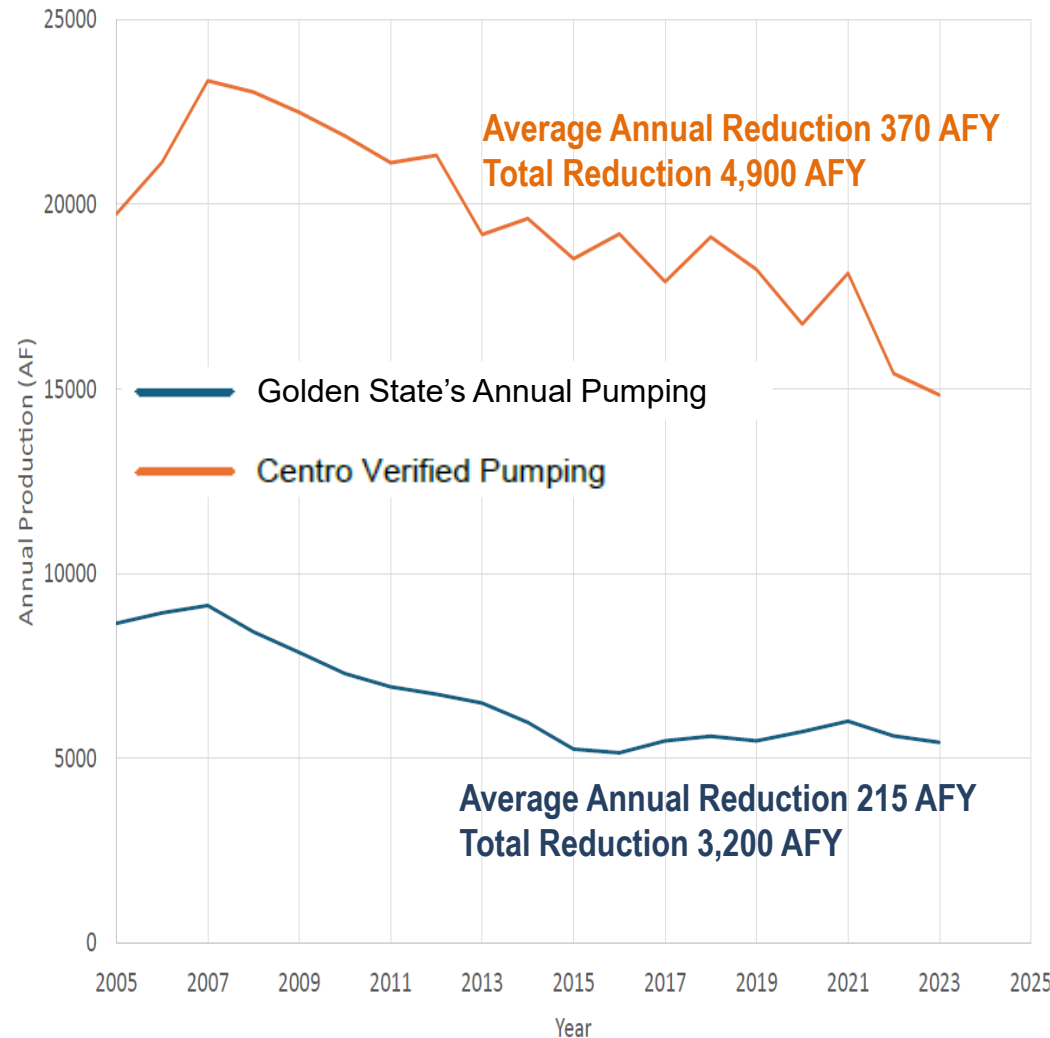

Conceptual Water Budgets

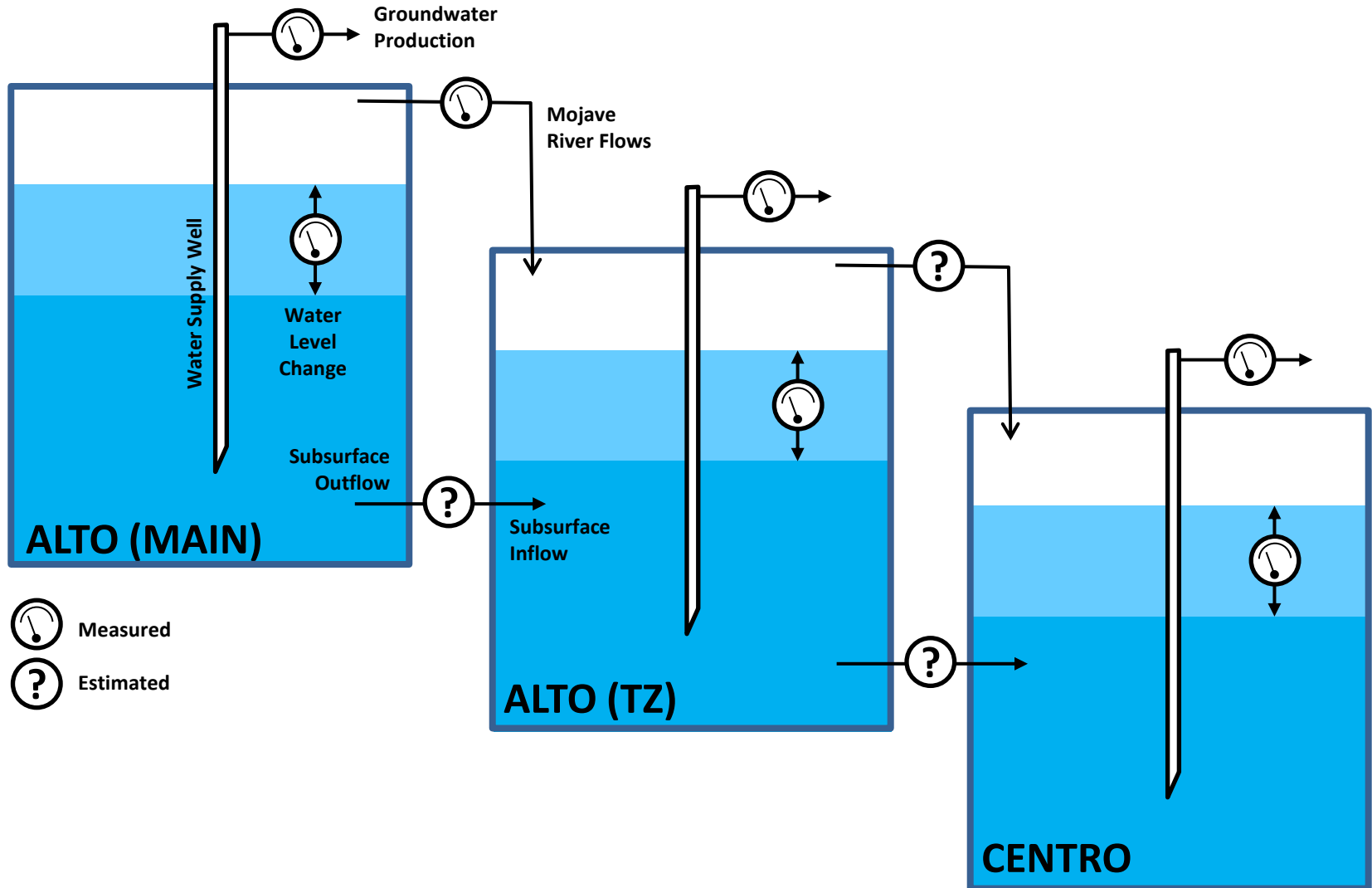

The Math Doesn't Add Up

- As noted, groundwater production in the Centro Subarea has been declining since **2007**
 - Average Centro verified production, 2007-2023 = 19,400 AFY
 - Average Golden State Centro production, 2007-2023 = 6,400 AFY
- Watermaster **estimates** inflow to the Centro Subarea averages about 37,000 AFY (surface + subsurface inflow) since 2007
 - However, there are no measurements of water inflow to Centro
- Watermaster: Average “paper” surplus 2001-2020 = 11,540 AFY
 - Includes additional outflows, mostly estimated or assumed by Watermaster
- Water levels declining in Golden State’s production wells
- What is explanation for this **discrepancy**?
- Where is the “surplus” water?

Watermaster's 2001-2020 Water Budgets

TABLE 5-1 Proposed

HYDROLOGICAL INVENTORY BASED ON VARIOUS SUPPLY ASSUMPTIONS AND 2021-22 CONSUMPTIVE USE, RETURN FLOW AND IMPORTS

(ALL AMOUNTS IN ACRE-FEET)

	ALTO	TRANSITION ZONE	CENTRO
WATER SUPPLY	2001-2020	2001-2020	2001-2020
Surface Water Inflow ¹	61,635	24,808	36,725
Mountain Front Recharge ²	8,511	0	0
Groundwater Discharge to the Transition Zone ³	0	5,112	0
Subsurface Inflow ⁴	0	7,053	2,000
Este/Oeste Inflow ⁵	4,785	62	
Imports ⁶	0	15,095	
TOTAL	74,931	52,130	38,725
CONSUMPTIVE USE AND OUTFLOW			
Surface Water Outflow	36,725 ⁷	36,725 ⁷	7,500 ⁴
Barstow Treatment Plant Discharge			2,475
Subsurface Outflow ⁸	2,000	2,000	1,462
Consumptive use ⁹			
Agriculture	949	949	5,863
Urban	40,171	6,456	6,885
Phreatophytes ¹⁰	11,000	6,000	3,000
TOTAL	90,845	52,130	27,185
Surplus / (Deficit) ¹¹	(15,914)		11,540
Total Estimated Production ¹²	78,147		16,995
Potential Return Flow from Surplus	0		2,885
PRODUCTION SAFE YIELD ¹³	62,233		31,420

¹ Average discharge of Mojave River by USGS, 2001-2020 (USGS stations at West Fork Mojave River Near Hesperia, CA (10261000), Deep Creek Near Hesperia, CA (10260500) and Lower Narrows Near Victorville, CA (10261500)).

² Mountain front recharge as developed from Upper Basin Alto Model.

³ Groundwater discharge lost to Transition Zone below the Narrows.

⁴ Portion of water lost to Transition Zone from Alto (Upper Basin Model). Groundwater discharge to Harper Lake (USGS Stamos 2001).

⁵ Subsurface Inflow to Alto from Este and Oeste Subareas (Upper Basin Model).

⁶ Total discharge to Transition Zone from VVWRA, 2021-22 Water Year.

⁷ Estimated based on reported flows at USGS gaging station, Mojave River at Victorville Narrows and 2001-2020

⁸ Groundwater discharge to Baja 1462 AF; 3501 AF groundwater discharge from Barstow area to Harper Lake. (USGS Stamos 2001)

⁹ Includes consumptive use of "Minimals Pool" (estimated Minimal's production is 2,104 af).

¹⁰ From USGS Water-Resources Investigation Report 96-4241 "Riparian Vegetation and Its Water Use During 1995 Along the Mojave River, Southern California" 1996. Lines and Bilhorn

¹¹ Amount necessary to offset overdraft under the above assumptions.

¹² Water production for 2021-22. Included in the production values are the estimated minimal producer's water use.

¹³ Imported State Water Project water purchased by MWA is not reflected in the above table.

¹⁴ Reported flows at USGS gaging station, Mojave River at Barstow (10262500).

Watermaster's 2001-2020 TZ Water Budget

Inflows (Water Supply)	Consumptive Uses and Outflow
Surface Water Inflow (Measured at Lower Narrows gage)	Surface Water Outflow (Assumed & Calculated)
Groundwater Discharge to Transition Zone (Assumed)	Subsurface Outflow (Assumed)
Subsurface Inflow (Modeled)	Consumptive Use – Agriculture & Urban (Measured & Estimated)
Este/Oeste Inflow (Modeled)	Phreatophytes (Assumed)
Imports (non-native) (Measured at VVWRA discharge)	---
Total: 52,130 AFY	Total: 52,130 AFY

Watermaster's 2001-2020 Centro Water Budget

Inflows (Water Supply)	Consumptive Uses and Outflow
Surface Water Inflow (Assumed)	Surface Water Outflow (Measured & Assumed)
Subsurface Inflow (Assumed)	Barstow Treatment Plant Discharge (Assumed)
---	Subsurface Outflow (Assumed)
---	Consumptive Uses – Agriculture & Urban (Measured & Estimated)
---	Phreatophytes (Assumed)
Total: 38,725 AFY	Total: 27,185 AFY

Mojave Basin Area

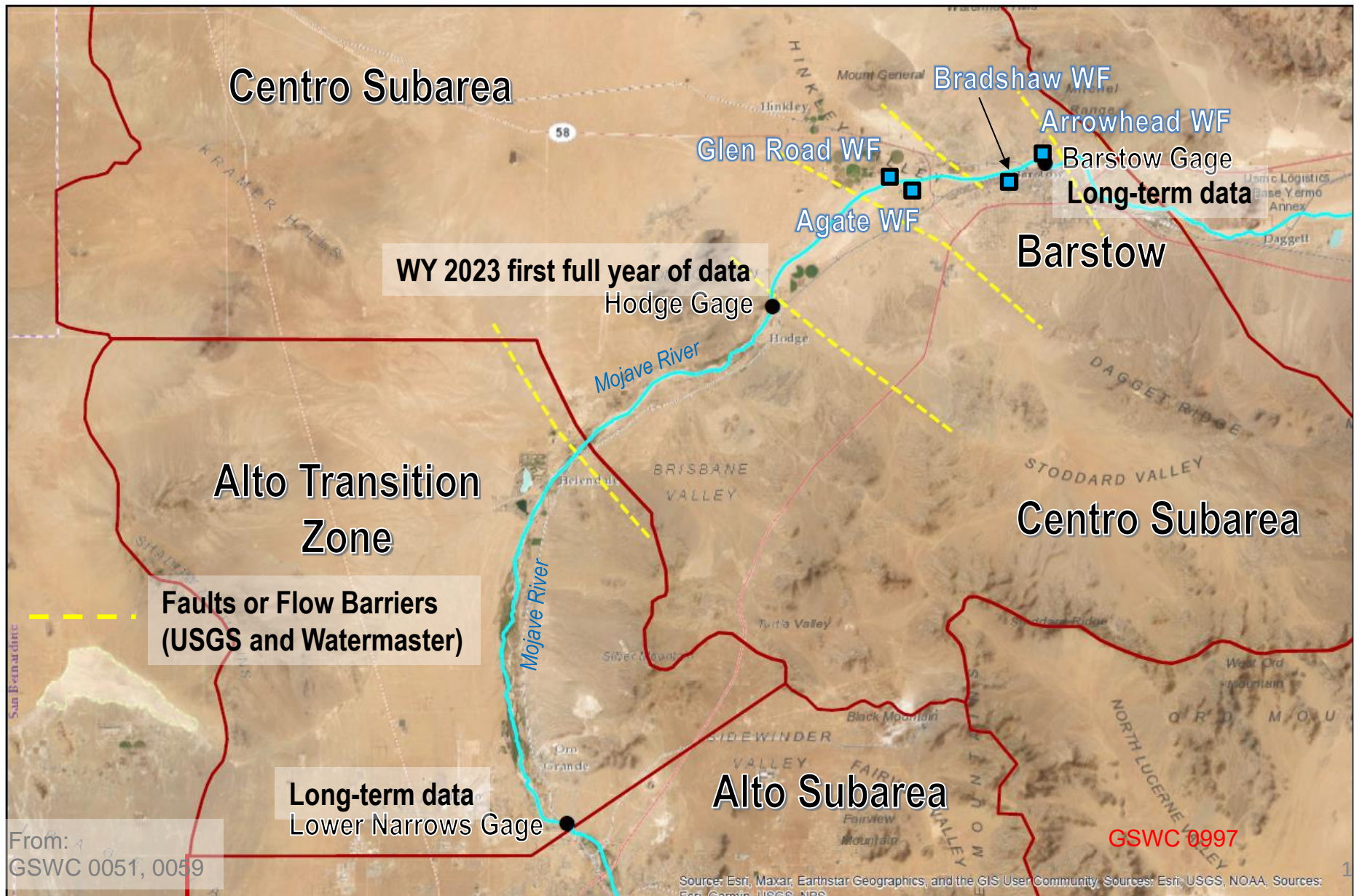

Groundwater Levels

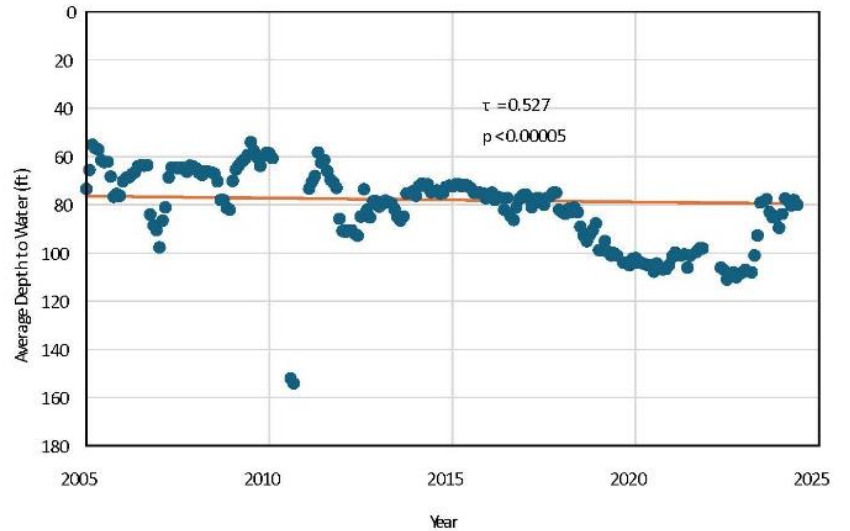
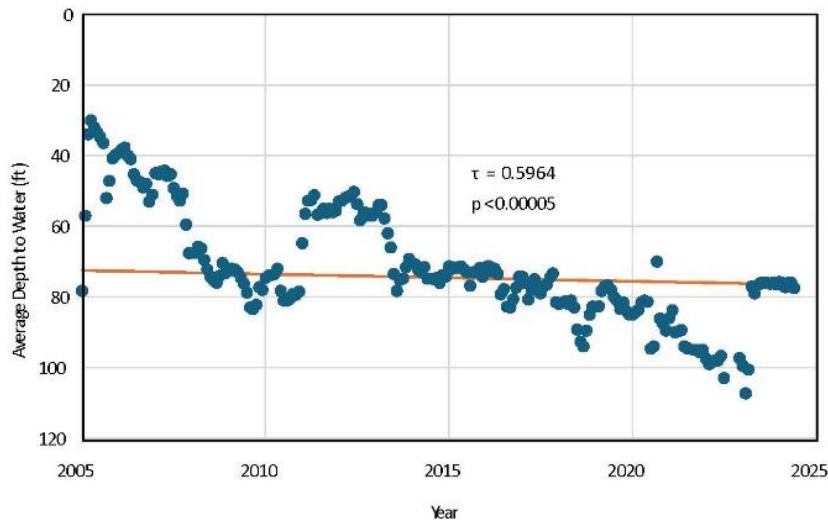
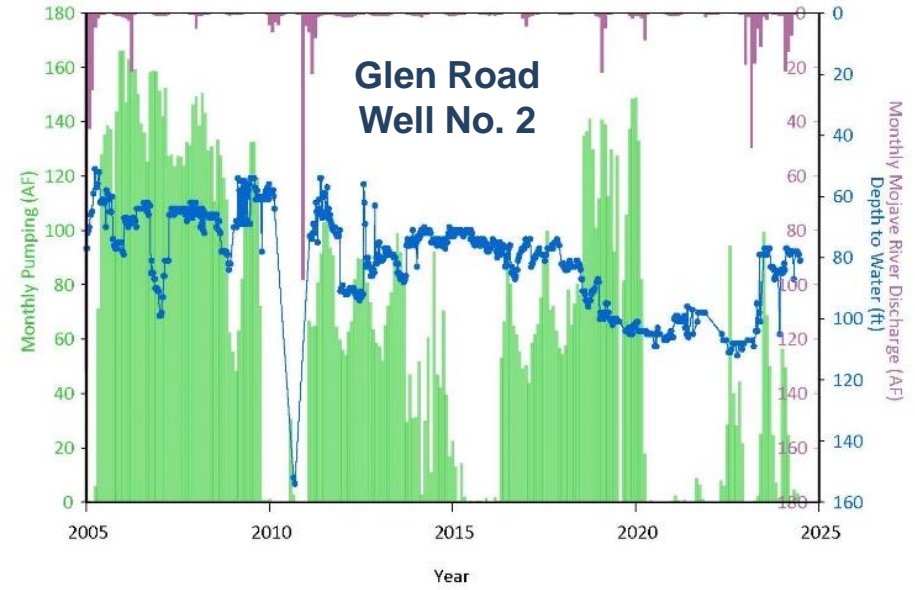
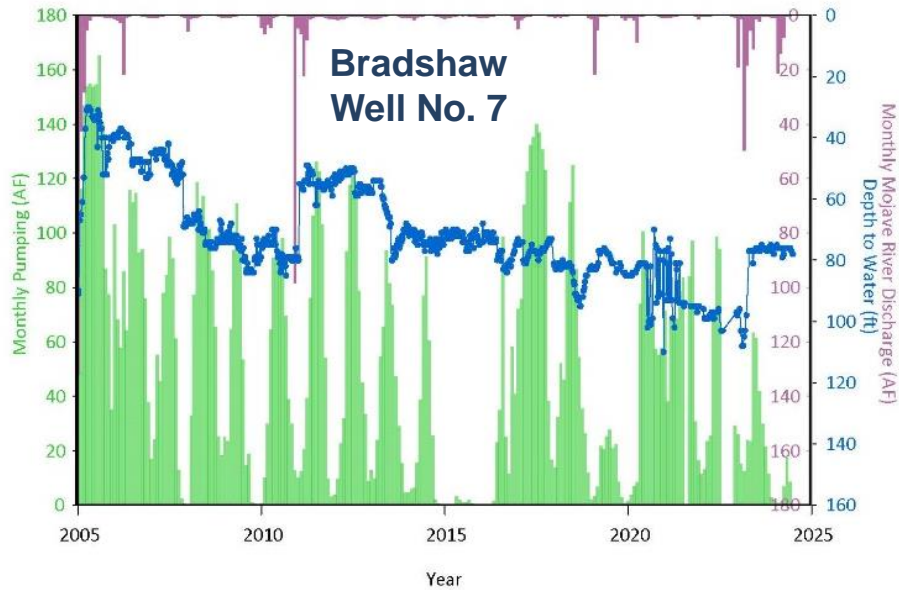

From:
GSWC 0068, GSWC 0076

GSWC 0998

Depth to Water and Monthly Pumping Correlation

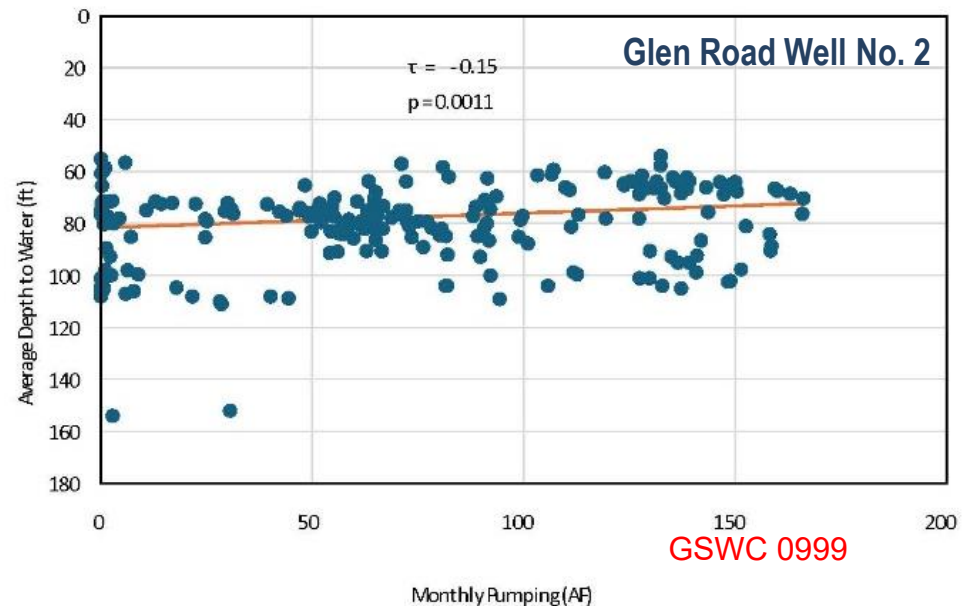
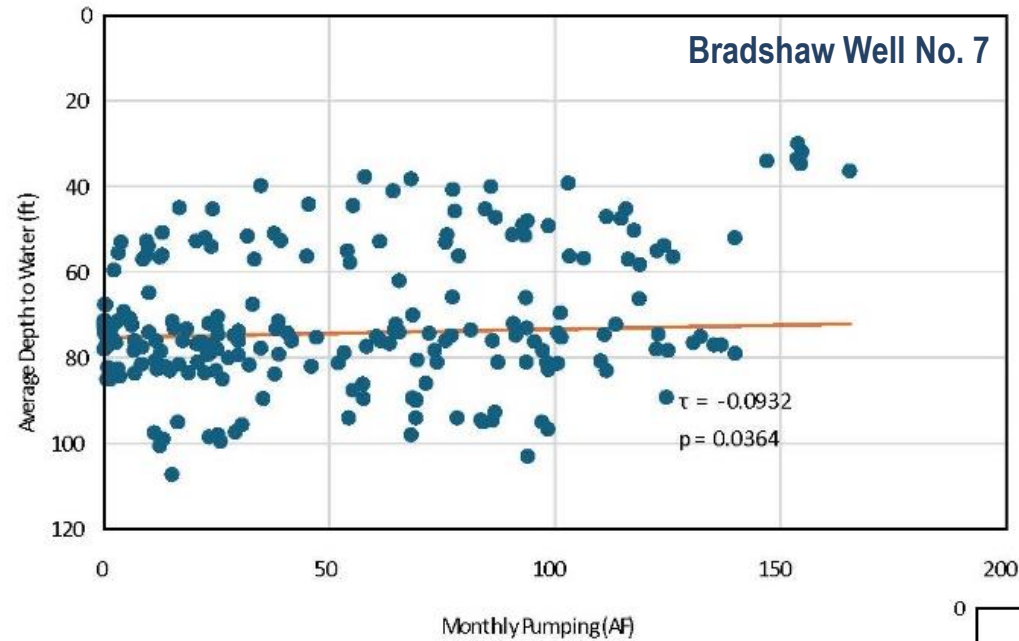

Statistical Correlations: Water Levels vs Time

- Most hydrographs show visually that depth to water (DTW) decrease sharply during and following large discharge events (i.e., storms)
 - Two of 17 hydrographs show general decreases after storms
 - One of 17 hydrographs lacks sufficient data
- Most hydrographs show statistically significant DTW increase over time
 - Seven of 17 hydrographs show DTW strongly increases over time
 - Eight of 17 hydrographs show DTW moderately increases over time
 - Two of 17 hydrographs show DTW weakly decreases over time

Statistical Correlations: Water Levels vs Pumping

- Most wells do **not** show statistically significant DTW increase with pumping
 - Six wells show **no correlation/trend** with pumping
 - Five wells show DTW **decreases** with pumping
 - Only one well shows DTW strongly increasing with pumping
 - Four wells show DTW weakly increasing with pumping; one shows DTW moderately increasing
- For wells that do show statistically significant DTW increase with pumping
 - Groundwater production is likely a minor component of the observed increases in DTW; increased DTW much more correlated with time
 - Likely that decreased inflow to Centro has contributed to increasing DTW (declining water levels)

Recommendations

1. Watermaster should re-evaluate the water budgets for Alto, the TZ, and Centro
 - a. Consumptive Use by agriculture and phreatophytes
 - b. Storage losses in the TZ
 - c. Subsurface flow between Alto and the TZ and thence to Centro
 - d. Surface water flows between the TZ and Centro
2. Watermaster should update the current UMRB model to include the entire adjudicated area subject to the Judgment, and then use the updated (and calibrated) model to reevaluate water budgets
3. Watermaster should perform additional statistical analyses to correlate groundwater levels in Alto, the TZ, and Centro

Recommendations (continued)

4. Based on results from the above, Watermaster should determine whether Producers in Alto have met, are currently meeting, and will meet their obligations to Centro
5. If Watermaster determines the obligation:
 - a. **Has not been, is not being, and will not be met**, then Watermaster should develop a plan to ensure they are met in the future and then implement such a plan and develop an approach to address past shortfalls in water delivery.
 - b. **Has been, is being, and will be met**, then Watermaster should recommend and implement additional analyses that would evaluate why chronic water levels declines are being observed at Golden State's production wells in Centro.

Thank You

PROOF OF SERVICE

I am over the age of eighteen years and not a party to the within-entitled action. I am employed in Santa Barbara County, California. My business address is Brownstein Hyatt Farber Schreck, LLP, 1021 Anacapa Street, 2nd Floor, Santa Barbara, California 93101-2711. My electronic service address is Meldridge@bhfs.com. On September 26, 2024, I served a copy of the following document(s):

NOTICE OF LODGING OF POWERPOINT PRESENTATION IN SUPPORT OF GOLDEN STATE WATER COMPANY'S MOTION TO ENFORCE JUDGMENT



BY E-MAIL OR ELECTRONIC TRANSMISSION: I caused a copy of the document(s) listed above to be sent to the persons at the e-mail addresses listed below

William J. Brunick, Esq.
Leland P. McElhaney, Esq.
Brunick, McElhaney & Kennedy, PLC
P. O. Box 13130
San Bernardino, CA 92423-3130
Email: bbrunick@bmklawplc.com
lmcelhaney@bmklawplc.com

Attorneys for Defendant/Cross-Complainant
Mojave Water Agency

Valerie Wiegenstein
Jeffrey D. Ruesch
Watermaster Services Managers
Mojave Basin Area Watermaster
Mojave Water Agency
13846 Conference Center Drive
Apple Valley, CA 92307
Email: vwiegenstein@MojaveWater.org
jruesch@mojavewater.org

Mojave Basin Area Watermaster

I declare under penalty of perjury under the laws of the State of California that the above is true and correct. Executed on September 26, 2024, at Santa Barbara, California.

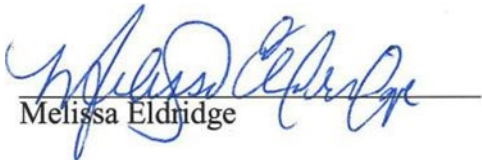
Melissa Eldridge

PROOF OF SERVICE

STATE OF CALIFORNIA }
COUNTY OF SAN BERNARDINO}

I am employed in the County of the San Bernardino, State of California. I am over the age of 18 and not a party to the within action; my business address is 13846 Conference Center Drive, Apple Valley, California 92307.

On September 30, 2024, the document(s) described below were served pursuant to the Mojave Basin Area Watermaster's Rules and Regulations paragraph 8.B.2 which provides for service by electronic mail upon election by the Party or paragraph 10.D, which provides that Watermaster shall mail a postcard describing each document being served, to each Party or its designee according to the official service list, a copy of which is attached hereto, and which shall be maintained by the Mojave Basin Area Watermaster pursuant to Paragraph 37 of the Judgment. Served documents will be posted to and maintained on the Mojave Water Agency's internet website for printing and/or download by Parties wishing to do so.

Document(s) filed with the court and served herein are described as follows:

NOTICE OF LODGING OF POWERPOINT PRESENTATION IN SUPPORT OF GOLDEN STATE WATER COMPANY'S MOTION TO ENFORCE JUDGMENT

 X (STATE) I declare under penalty of perjury under the laws of the State of California that the above is true and correct.

Executed on September 30, 2024 at Apple Valley, California.

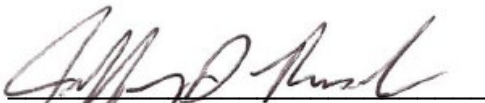

Jeffrey D. Ruesch

Mojave Basin Area Watermaster Service List as of September 30, 2024

Attn: Roberto Munoz
35250 Yermo, LLC
11273 Palms Blvd., Ste. D.
Los Angeles, CA 90066-2122

Attn: John McCallum
Abshire, David V.
PO Box # 2059
Lucerne Valley, CA 92356-2059

Attn: Jessie Florez
Adelanto, City Of
11600 Air Expressway
Adelanto, CA 92301-1914

(adesdevon@gmail.com)
Ades, John and Devon (via email)

Attn: Pedro Dumaua
(pdumaua@ducommun.com)
Aerochem, Inc. (via email)
4001 El Mirage Rd.
Adelanto, CA 92301-9489

Attn: Lori Clifton (lclifton@robar.com)
Agcon, Inc. (via email)
17671 Bear Valley Road
Hesperia, CA 92345-4902

Attn: Chun Soo and Wha Ja Ahn
(chunsooahn@naver.com)
Ahn Revocable Living Trust (via email)
P. O. Box 45
Apple Valley, CA 92307-0001

Attn: Simon Ahn (ssahn58@gmail.com)
Ahn Revocable Trust (via email)
29775 Hunter Road
Murrieta, CA 92563-6710

Attn: Chun Soo Ahn
(davidahnmd@gmail.com,
chunsooahn@naver.com;
davidahn0511@gmail.com)
Ahn, Chun Soo and David (via email)
P. O. Box 45
Apple Valley, CA 92307-0001

Attn: Chun Soo Ahn
(chunsooahn@naver.com)
Ahn, Chun Soo and Wha Ja (via email)
P. O. Box 45
Apple Valley, CA 92307-0001

Ake, Charles J. and Marjorie M.
2301 Muriel Drive, Apt. 67
Barstow, CA 92311-6757

Attn: Paul Tsai (paul@ezzlife.com)
America United Development, LLC (via email)
19625 Shelyn Drive
Rowland Heights, CA 91748-3246

Attn: Ana Chavez
American States Water Company
160 Via Verde, Ste. 100
San Dimas, CA 91773-5121

Anderson, Ross C. and Betty J.
13853 Oakmont Dr.
Victorville, CA 92395-4832

Attn: Daniel B. Smith (avfwd@gmail.com)
Apple Valley Foothill County Water District
(via email)
22545 Del Oro Road
Apple Valley, CA 92308-8206

Attn: Matthew Patterson
Apple Valley Heights County Water District
P. O. Box 938
Apple Valley, CA 92308-0938

Attn: Matthew Schulenberg
Apple Valley Unified School District
12555 Navajo Road
Apple Valley, CA 92308-7256

Attn: Emely and Joe Saltmeris
Apple Valley View Mutual Water Company
P. O. Box 3680
Apple Valley, CA 92307-0072

Attn: Tina Kuhns
Apple Valley, Town Of
14955 Dale Evans Parkway
Apple Valley, CA 92307-3061

(ArchibekFarms@gmail.com;
Sandi.Archibek@gmail.com)
Archibek, Eric (via email)
41717 Silver Valley Road
Newberry Springs, CA 92365-9517

Avila, Angel and Evalia
1523 S. Visalia
Compton, CA 90220-3946

Attn: Sheré R. Bailey
(LegalPeopleService@gmail.com)
Bailey 2007 Living Revocable Trust, Sheré R.
(via email)
10428 National Blvd
Los Angeles, CA 90034-4664

Attn: Daniel Shaw (barhwater@gmail.com)
Bar H Mutual Water Company (via email)
P. O. Box 844
Lucerne Valley, CA 92356-0844

Barber, James B.
43774 Cottonwood Road
Newberry Springs, CA 92365

Attn: John Munoz
(barlenwater@hotmail.com);
Bar-Len Mutual Water Company (via email)
P. O. Box 77
Barstow, CA 92312-0077

Attn: Curtis Palmer
Baron, Susan and Palmer, Curtis
141 Road 2390
Aztec, NM 87410-9322

Attn: Jennifer Riley (hriley@barstowca.org)
Barstow, City of (via email)
220 East Mountain View Street -Suite A
Barstow, CA 92311

Mojave Basin Area Watermaster Service List as of September 30, 2024

Bartels, Gwendolyn J.
156 W 100 N
Jerome, ID 83338-5256

Attn: Barbara Davisson
Bass Trust, Newton T.
14924 Chamber Lane
Apple Valley, CA 92307-4912

Attn: Remo E. Bastianon
Bastianon Revocable Trust
9484 Iroquois Rd.
Apple Valley, CA 92308-9151

Attn: Mike Beinschroth
(Beinschroth@gmail.com)
Beinschroth Family Trust (via email)
18794 Sentenac Road
Apple Valley, CA 92307-5342

Beinschroth, Andy Eric
6719 Deep Creek Road
Apple Valley, CA 92308-8711

Attn: Chuck Bell (Chuckb193@outlook.com;
Chuckb193@outlook.com)
Bell, Charles H. Trust dated March 7, 2014
(via email)
P. O. Box 193
Lucerne Valley, CA 92356-0193

Best, Byron L.
21461 Camino Trebol
Lake Forest, CA 92630-2011

Attn: Deborah Stephenson
(stephenson@dmsnaturalresources.com;
Jason.Murray@bnsf.com;
Blaine.Bilderback@bnsf.com)
BNSF Railway Company (via email)
602 S. Ferguson Avenue, Suite 2
Bozeman, MT 59718-

Attn: Deborah Stephenson
(stephenson@dmsnaturalresources.com)
BNSF Railway Company (via email)
602 S. Ferguson Avenue, Suite 2
Bozeman, MT 59718-6483

Borja, Leonil T. and Tital L.
20784 Iris Canyon Road
Riverside, CA 92508-

Box, Geary S. and Laura
P. O. Box 402564
Hesperia, CA 92340-2564

Attn: Marvin Brommer
Brommer House Trust
9435 Strathmore Lane
Riverside, CA 92509-0941

Attn: Valeria Brown
Brown Family Trust Dated August 11, 1999
26776 Vista Road
Helendale, CA 92342-9789

Brown, Jennifer
10001 Choiceana Ave.
Hesperia, CA 92345

Bruneau, Karen
19575 Bear Valley Rd.
Apple Valley, CA 92308-5104

Attn: Ian Bryant (irim@aol.com)
Bryant Family Trust dated May 9, 2007 (via
email)
15434 Sequoia Avenue - Office
Hesperia, CA 92345-1667

(bubierbear@msn.com)
Bubier, Diane Gail (via email)
46263 Bedford Rd.
Newberry Springs, CA 92365-9819

Attn: Noah Furie
Budget Finance Company
PO BOX 641339
Los Angeles, CA 90064-6339

Bunnell, Dick
8589 Volga River Circle
Fountain Valley, CA 92708-5536

(kjbc@yahoo.com)
Bush, Kevin (via email)
7768 Sterling Ave.
San Bernardino, CA 92410-4741

Attn: Kristie Wright
(Kristie.Wright@associa.us)
Calico Lakes Homeowners Association (via
email)
11860 Pierce Street, Suite 100
Riverside, CA 92505-5178

Attn: William DeCoursey
(michael.lemke@dot.ca.gov;
William.Decoursey@dot.ca.gov)
California Department Of Transportation (via
email)
175 W. Cluster
San Bernardino, CA 92408-1310

Attn: Robert W. Bowcock
CalMat Company
405 N. Indian Hill Blvd.
Claremont, CA 91711-4614

Attn: Catalina Fernandez-Moores
(celias@calportland.com)
CalPortland Company - Agriculture (via email)
P. O. Box 146
Oro Grande, CA 92368-0146

Attn: Catalina Fernandez-Moores
(cfernandez@calportland.com)
CalPortland Company - Oro Grande Plant (via
email)
P. O. Box 146
Oro Grande, CA 92368-0146

Attn: Tony Camanga
Camanga, Tony and Marietta
2309 Highland Heights Lane
Carrollton, TX 75007-2033

Attn: Myron Campbell II
Campbell, M. A. and Dianne
19327 Cliveden Ave
Carson, CA 90746-2716

Mojave Basin Area Watermaster Service List as of September 30, 2024

Carlton, Susan
445 Via Colusa
Torrance, CA 90505-

Attn: Denise Parra
Casa Colina Foundation
P.O. Box 1760
Lucerne Valley, CA 92356

Attn: Danielle Stewart
(danielle.stewart@wildlife.ca.gov;
Richard.Kim@wildlife.ca.gov;
Alisa.Ellsworth@wildlife.ca.gov)
CDFW - Camp Cady (via email)
4775 Bird Farm Road
Chino Hills, CA 91709-3175

Attn: Beahtha Davis
CDFW - Mojave Narrows Regional Park
268 W. Hospitality Lane, 3rd Floor
San Bernardino, CA 92408-3241

Attn: Paco Cabral
(paco.cabral@wildlife.ca.gov;
askregion6@wildlife.ca.gov;
aaron.johnson@wildlife.ca.gov)
CDFW - Mojave River Fish Hatchery (via
email)
12550 Jacaranda Avenue
Victorville, CA 92395-5183

Attn: Environmental
(valorie.moore@cemex.com)
Cemex, Inc. (via email)
16888 North E. Street
Victorville, CA 92394-2999

Attn: Jennifer Cutler
Center Water Company
P. O. Box 616
Lucerne Valley, CA 92356-0616

Attn: Nancy Ryman
Chamisal Mutual Water Company
P. O. Box 1444
Adelanto, CA 92301-2779

Attn: Carl Pugh (talk2betty@aol.com;
cpugh3@aol.com)
Cheyenne Lake, Inc. (via email)
44658 Valley Center Rd.
Newberry Springs, CA 92365-

Attn: Micahel Chisram
Chisram, et al.
414 S. Lincoln Ave.
Monterey Park, CA 91775-3323

Choi, Yong Il and Joung Ae
34424 Mountain View Road
Hinkley, CA 92347-9412

(joan.chong7@gmail.com;
joancksp@hotmail.com)
Chong, Joan (via email)
10392 Shady Ridge Drive
Santa Ana, CA 92705-7509

Christison, Joel
P. O. Box 2635
Big River, CA 92242-2635

Attn: Hwa-Yong Chung
Chung, et al.
11446 Midway Ave.
Lucerne Valley, CA 92356-8792

Clark, Arthur
P. O. Box 4513
Blue Jay, CA 92317-4513

Attn: Manoucher Sarbaz
Club View Partners
9903 Santa Monica Blvd., PMB #541
Beverly Hills, CA 90212-1671

Attn: Jaehwan Lee
Come Mission, Inc.
9965 Baker Road
Lucerne Valley, CA 92365-8490

Conner, William H.
11535 Mint Canyon Rd.
Agua Dulce, CA 91390-4577

Contratto, Ersula
13504 Choco Road
Apple Valley, CA 92308-4550

Attn: George Starke
Corbridge, Linda S.
8743 Vivero St
Rancho Cucamonga, CA 91730-

Cross, Sharon I.
P. O. Box 922
Lucerne Valley, CA 92356

Attn: Jay Hooper (jayho123@gmail.com)
Crown Cambria, LLC (via email)
9860 Gidley St.
El Monte, CA 91731-1110

Attn: Alessia Morris
Crystal Lakes Property Owners Association
P. O. Box 351
Yermo, CA 92398-0351

(dacostadean@gmail.com)
DaCosta, Dean Edward (via email)
32307 Foothill Road
Lucerne Valley, CA 92356-8526

Attn: Shanna Mitchell (daggettcsd@aol.com;
daggettcsd@outlook.com;
daggettwater427@gmail.com)
Daggett Community Services District (via
email)
P. O. Box 308
Daggett, CA 92327-0308

Attn: Steve and Dana Rivett
Daggett Ranch, LLC
P. O. Box 112
Daggett, CA 92327-0112

Attn: James Kelly
(James.Kelly@clearwayenergy.com)
Daggett Solar Power 3 LLC (via email)
5780 Fleet Street, Suite 130
Carlsbad, CA 92008-4715

Mojave Basin Area Watermaster Service List as of September 30, 2024

(ron@dadcopowerandlights.com)
Dahlquist, George R. (via email)
8535 Vine Valley Drive
Sun Valley, CA 91352-

Darr, James S.
40716 Highway 395
Boron, CA 93516

Attn: Alan L. De Jong
De Jong Family Trust
46561 Fairview Road
Newberry Springs, CA 92365-9230

Attn: Randy Wagner
Dennison, Quentin D. - Clegg, Frizell and Joke
44579 Temescal Street
Newberry Springs, CA 92365

Attn: Marie McDaniel
Desert Dawn Mutual Water Company
P. O. Box 392
Lucerne Valley, CA 92356-0392

Attn: Penny Zaritsky
(pennyzaritsky2000@yahoo.com)
Desert Girlz LLC (via email)
P. O. Box 709
Lucerne Valley, CA 92356-0709

Attn: Denise Courtney
Desert Springs Mutual Water Company
P. O. Box 396
Lucerne Valley, CA 92356-0396

Attn: Debby Wyatt
DLW Revocable Trust
13830 Choco Rd.
Apple Valley, CA 92307-5525

Attn: Judith Dolch-Partridge, Trustee
Dolch Living Trust Robert and Judith
4181 Kramer Lane
Bellingham, WA 98226-7145

Donaldson, Jerry and Beverly
16736 B Road
Delta, CO 81416-8501

Attn: Jeffery Lidman
Dora Land, Inc.
P. O. Box 1405
Apple Valley, CA 92307-0026

Attn: David Dorrance
Dorrance, David W. and Tamela L.
118 River Road Circle
Wimberley, TX 78676-5060

Attn: David Looper
Douglass, Tina
P.O. Box 1730
Lucerne Valley, CA 92356-

Dowell, Leonard
345 E Carson St.
Carson, CA 90745-2709

Evenson, Edwin H. and Joycelaine C.
P. O. Box 66
Oro Grande, CA 92368-0066

Attn: Stephanie L. Evert
(severt2166@aol.com)
Evert Family Trust (via email)
19201 Parker Circle
Villa Park, CA 92861-1302

Attn: David Dittenmore
(d2dittenmore@bop.gov; rslayman@bop.gov)
Federal Bureau of Prisons, Victorville (via email)
P. O. Box 5400
Adelanto, CA 92301-5400

Fejfar, Monica Kay
34080 Ord Street
Newberry Springs, CA 92365-9791

(wwcc0626@gmail.com)
Feng, Jinbao (via email)
33979 Fremont Road
Newberry Springs, CA 92365-9136

(afc30@yahoo.com)
Fernandez, Arturo (via email)
28 Calle Fortuna
Rancho Santa Margarita, CA 92688-2627

Ferro, Dennis and Norma
1311 1st Ave. N
Jacksonville Beach, FL 32250-3512

(ropingmom3@yahoo.com)
Finch, Jenifer (via email)
9797 Lewis Lane
Apple Valley, CA 92308-8357

Attn: Alex and Jerrica Liu
(alexliu1950@gmail.com; alexroseanneliu@yahoo.com)
First CPA LLC (via email)
46669 Valley Center Rd
Newberry Springs, CA 92365-

Attn: Mike Fischer
(carlsfischer@hotmail.com; fischer@fischercompanies.com)
Fischer Revocable Living Trust (via email)
1372 West 26th St.
San Bernardino, CA 92405-3029

Attn: Paul Johnson
Fisher Trust, Jerome R.
7603 Hazeltine Ave
Van Nuys, CA 91405-1423

Attn: Daisy Cruz
Foothill Estates MHP, LLC
9454 Wilshire Blvd., Ste. 920
Beverly Hills, CA 90212-2925

(cfrates@renewablegroup.com)
Frates, D. Cole (via email)
113 S La Brea Ave., 3rd Floor
Los Angeles, CA 90036-2998

Attn: Deborah A. Friend
Friend, Joseph and Deborah
P. O. Box 253
Barstow, CA 92312-0253

Attn: Mark Asay (bettybrock@ironwood.org; waltbrock@ironwood.org)
Fundamental Christian Endeavors, Inc. (via email)
49191 Cherokee Road
Newberry Springs, CA 92365

Gabrych, Eugene
2006 Old Highway 395
Fallbrook, CA 92028

Mojave Basin Area Watermaster Service List as of September 30, 2024

Gabrych, Eugene
2006 Old Highway 395
Fallbrook, CA 92028-8816

Gaeta, Miguel and Maria
9366 Joshua Avenue
Lucerne Valley, CA 92356-8273

Attn: Jay Storer
Gaeta, Trinidad
10551 Dallas Avenue
Lucerne Valley, CA 92356

Garcia, Daniel
223 Rabbit Trail
Lake Jackson, TX 77566-3728

Attn: Sang Hwal Kim
Gardena Mission Church, Inc.
P. O. Box 304
Lucerne Valley, CA 92356-0304

Garg, Om P.
358 Chorus
Irvine, CA 92618-1414

Attn: Brent Peterson
Gayjikian, Samuel and Hazel
34534 Granite Road
Lucerne Valley, CA 92356-

Attn: Jeffrey Edwards
(jedwards@fbremediation.com)
GenOn California South, LP (via email)
P. O. Box 337
Daggett, CA 92327-0337

(Nereida.Gonzalez@gswater.com,
ana.chavez@gswater.com)
Golden State Water Company (via email)
160 Via Verde, Ste. 100
San Dimas, CA 91773-5121

Attn: Nereida Gonzalez
(ana.chavez@gswater.com,
Nereida.Gonzalez@gswater.com)
Golden State Water Company (via email)
160 Via Verde, Ste. 100
San Dimas, CA 91773-5121

Attn: Scot Gasper
Gordon Acres Water Company
P. O. Box 1035
Lucerne Valley, CA 92356-1035

Gray, George F. and Betty E.
975 Bryant
Calimesa, CA 92320-1301

Attn: Brian E. Bolin
Green Acres Estates
P. O. Box 29
Apple Valley, CA 92307-0001

Attn: Eric Archibek
Green Hay Packers LLC
41717 Silver Valley Road
Newberry Springs, CA 92365-9517

Attn: Nick Grill (terawatt@juno.com)
Grill, Nicholas P. and Millie D. (via email)
35350 Mountain View Rd
Hinkley, CA 92347-9613

Gubler, Hans
P. O. Box 3100
Landers, CA 92285

Attn: Tamara J Skoglund
(TamaraMcKenzie@aol.com)
Gulbranson, Merlin (via email)
511 Minnesota Ave W
Gilbert, MN 55741-

Gutierrez, Jose and Gloria
24116 Santa Fe
Hinkley, CA 92347

Attn: Bryan C. Haas and Mary H. Hinkle
(resrv4you@aol.com)
Haas, Bryan C. and Hinkle, Mary H. (via
email)
14730 Tigertail Road
Apple Valley, CA 92307-5249

(hackbarthoffice@gmail.com)
Hackbarth, Edward E. (via email)
12221 Poplar Street, Unit #3
Hesperia, CA, CA 92344-9287

Attn: Doug and Cheryl Hamilton
Hamilton Family Trust
19945 Round Up Way
Apple Valley, CA 92308-8338

Attn: William Handrinos
Handrinos, Nicole A.
1140 Parkdale Rd.
Adelanto, CA 92301-9308

Hang, Phu Quang
645 S. Shasta Street
West Covina, CA 91791-2818

Attn: Donald F. Hanify
Hanify, Michael D., dba - White Bear Ranch
PO BOX 1021
Yermo, CA 92398-1021

Attn: Matt Wood
(Matthew.wood@martinmarietta.com)
Hanson Aggregates WRP, Inc. (via email)
P. O. Box 1115
Corona, CA 92878-1115

Attn: Mary Jane Hareson
Hareson, Nicholas and Mary
1737 Anza Avenue
Vista, CA 92084-3236

Attn: Kenny Harmsen (harmsecow@aol.com)
Harmsen Family Trust (via email)
23920 Community Blvd.
Hinkley, CA 92347-9721

Harter, Joe and Sue
10902 Swan Lake Road
Klamath Falls, OR 97603-9676

(harveyl.92356@gmail.com)
Harvey, Lisa M. (via email)
P. O. Box 1187
Lucerne Valley, CA 92356-

Haskins, James J.
11352 Hesperia Road, #2
Hesperia, CA 92345-2165

Mojave Basin Area Watermaster Service List as of September 30, 2024

Hass, Pauline L.
P. O. Box 273
Newberry Springs, CA 92365-

Attn: Craig Carlson (kcox@helendalecsd.org;
ccarlson@helendalecsd.org)
Helendale Community Services District (via
email)
P. O. Box 359
Helendale, CA 92342-0359

Attn: Joshua Maze
Helendale School District
P. O. Box 249
Helendale, CA 92342-0249

Attn: Jeff Gallistel
Hendley, Rick and Barbara
P. O. Box 972
Yermo, CA 92398-0972

Hensley, Mark P.
35523 Mountain View Rd
Hinkley, CA 92347-9613

Attn: Jeremy McDonald
(jmcdonald@cityofhesperia.us)
Hesperia - Golf Course, City of (via email)
9700 Seventh Avenue
Hesperia, CA 92345-3493

Attn: Janie Martinez
(janiemartines@gmail.com)
Hesperia Venture I, LLC (via email)
10 Western Road
Wheatland, WY 82201-8936

Attn: Jeremy McDonald
(jmcdonald@cityofhesperia.us)
Hesperia Water District (via email)
9700 7th Avenue
Hesperia, CA 92345-3493

Attn: Jeremy McDonald
(tsouza@cityofhesperia.us)
Hesperia, City of (via email)
9700 Seventh Avenue
Hesperia, CA 92345-3493

Attn: Carabeth Carter ()
Hettinga Revocable Trust (via email)
P. O. Box 455
Ehrenberg, AZ 84334-0455

Attn: Lisset Sardeson
Hi Desert Mutual Water Company
23667 Gazana Street
Barstow, CA 92311

(leehiett@hotmail.com)
Hiett, Harry L. (via email)
P. O. Box 272
Daggett, CA 92327-0272

Attn: Robert W. Bowcock
High Desert Associates, Inc.
405 North Indian Hill Blvd.
Claremont, CA 91711-4614

Attn: Lori Clifton (lclifton@robar.com)
Hi-Grade Materials Company (via email)
17671 Bear Valley Rd
Hesperia, CA 92345-4902

Attn: Lori Clifton (lclifton@robar.com)
Hi-Grade Materials Company (via email)
17671 Bear Valley Road
Hesperia, CA 92345-4902

Attn: Frank Hilarides
Hilarides 1998 Revocable Family Trust
37404 Harvard Road
Newberry Springs, CA 92365

Attn: Katherine Hill (Khill9@comcast.net)
Hill Family Trust and Hill's Ranch, Inc. (via
email)
84 Dewey Street
Ashland, OR 97520-

Attn: Anne Roark
Hitchin Lucerne, Inc.
P. O. Box 749
Lucerne Valley, CA 92356-0749

Ho, Ting-Seng and Ah-Git
P.O. Box 20001
Bakersfield, CA 93390-0001

Attn: Joan Rohrer
Hollister, Robert H. and Ruth M.
22832 Buendia
Mission Viejo, CA 92691-

Attn: Jeffrey R Holway and Patricia Gage
(patricia.gage@yahoo.com)
Holway Jeffrey R and Patricia Gage (via
email)
1401 Wewatta St. #1105
Denver, CO 80202-1348

Holway, Jeffrey R
1401 Wewatta St. #1105
Denver, CO 80202-1348

Attn: Katherine K. Hsu
Holy Heavenly Lake, LLC
1261 S. Lincoln Ave.
Monterey Park, CA 91755-5017

Attn: Paul Hong
Hong, Paul B. and May
P. O. Box #1432
Covina, CA 91722-0432

Attn: Sandra D. Hood
Hood Family Trust
2142 W Paseo Del Mar
San Pedro, CA 90732-4557

Attn: Barry Horton
Horton Family Trust
47716 Fairview Road
Newberry Springs, CA 92365-9258

Attn: Ester Hubbard
Hubbard, Ester and Mizuno, Arlean
47722 Kiloran St.
Newberry Springs, CA 92365-9529

Attn: Paul Johnson
Huerta, Hector
25684 Community Blvd
Barstow, CA 92311-

(hconnie630@gmail.com)
Hunt, Connie (via email)
39392 Burnside Loop
Astoria, OR 97103-8248

Attn: Ralph Hunt
Hunt, Ralph M. and Lillian F.
P. O. Box 603
Yermo, CA 92398-0603

Mojave Basin Area Watermaster Service List as of September 30, 2024

Attn: Daniel and Karen Gray
(calivolunteer@verizon.net)
Hyatt, James and Brenda (via email)
31726 Fremont Road
Newberry Springs, CA 92365

(econorx@yahoo.com)
Im, Nicholas Nak-Kyun (via email)
23329 Almarosa Ave.
Torrance, CA 90505-3121

Irvin, Bertrand W.
3224 West 111th Street
Inglewood, CA 90303-

Attn: James Jackson Jr.
Jackson, James N. Jr Revocable Living Trust
1245 S. Arlington Avenue
Los Angeles, CA 90019-3517

Attn: Lawrence Dean
Jackson, Ray Revocable Trust No. 45801
P.O. Box 8250
Redlands, CA 92375-1450

Attn: Audrey Goller
(audrey.goller@newportpacific.com)
Jamboree Housing Corporation (via email)
15940 Stoddard Wells Rd - Office
Victorville, CA 92395-2800

Attn: Gary A. Ledford
(gleddream@gmail.com)
Jess Ranch Water Company (via email)
906 Old Ranch Road
Florissant, CO 80816-

Attn: Cynthia Mahoney
(cyndisue87@yahoo.com)
Johnson, Carlean F. Trust Dated 10/29/2004
(via email)
8626 Deep Creek Road
Apple Valley, CA 92308-8769

Attn: Paul Johnson
(johnsonfarming@gmail.com)
Johnson, Paul - Industrial (via email)
10456 Deep Creek Road
Apple Valley, CA 92308-8330

Johnson, Ronald
1156 Clovis Circle
Dammeron Valley, UT 84783-5211

Attn: Lawrence W. Johnston
Johnston, Harriet and Johnston, Lawrence W.
P. O. Box 401472
Hesperia, CA 92340-1472

Attn: Magdalena Jones
(mygoldenbiz9@gmail.com)
Jones Trust dated March 16, 2002 (via email)
35424 Old Woman Springs Road
Lucerne Valley, CA 92356-7237

Attn: Paul Jordan
Jordan Family Trust
1650 Silver Saddle Drive
Barstow, CA 92311-2057

Attn: Ray Gagné
Jubilee Mutual Water Company
P. O. Box 1016
Lucerne Valley, CA 92356

Attn: Lee Logsdon
Juniper Riviera County Water District
P. O. Box 618
Lucerne Valley, CA 92356-0618

Attn: Ash Karimi
Karimi, Hooshang
1254 Holmby Ave
Los Angeles, CA 90024-

Attn: Robert R. Kasner
(Robertkasner@aol.com)
Kasner Family Limited Partnership (via email)
11584 East End Avenue
Chino, CA 91710-

(Robertkasner@aol.com)
Kasner, Robert (via email)
11584 East End Avenue
Chino, CA 91710-1555

Attn: Martin A and Mercedes Katcher
Katcher, August M. and Marceline
12928 Hyperion Lane
Apple Valley, CA 92308-4565

Kemp, Robert and Rose
48441 National Trails Highway
Newberry Springs, CA 92365

Attn: Peggy Shaughnessy
Kemper Campbell Ranch
10 Kemper Campbell Ranch Road - Office
Victorville, CA 92395-3357

Kim, Jin S. and Hyun H.
6205 E Garnet Circle
Anaheim, CA 92807-4857

Attn: Alan and Annette De Jong
Kim, Joon Ho and Mal Boon Revocable Trust
46561 Fairview Road
Newberry Springs, CA 92365-9230

(juskim67@yahoo.com)
Kim, Ju Sang (via email)
1225 Crestview Dr
Fullerton, CA 92833-2206

Kim, Seon Ja
34981 Piute Road
Newberry Springs, CA 92365-9548

Attn: Richard Koering
Koering, Richard and Koering, Donna
40909 Mountain View Road
Newberry Springs, CA 92365-9414

Attn: Catherine Cerri
(ccerri@lakearrowheadscsd.com)
Lake Arrowhead Community Services District
(via email)
P. O. Box 700
Lake Arrowhead, CA 92352-0700

Mojave Basin Area Watermaster Service List as of September 30, 2024

Attn: Claire Cabrey
(HandleWithClaire@aol.com;
mjaynes@mac.com)
Lake Jodie Property Owners Association (via
email)
8581 Santa Monica Blvd., #18
West Hollywood, CA 90069-4120

(PhillipLam99@Yahoo.com)
Lam, Phillip (via email)
864 Sapphire Court
Pomona, CA 91766-5171

Attn: Robert Lawrence Jr.
Lawrence, William W.
P. O. Box 98
Newberry Springs, CA 92365

Lee, Doo Hwan
P. O. Box 556
Lucerne Valley, CA 92356-0556

Attn: Virginia Janovsky
(virginiajanovsky@yahoo.com)
Lem, Hoy (via email)
17241 Bullock St.
Encino, CA 91316-1473

Attn: Billy Liang
Liang, Yuan - I and Tzu - Mei Chen
4192 Biscayne St
Chino, CA 91710-3196

Attn: Manshan Gan
Lo, et al.
5535 N Muscatel Ave
San Gabriel, CA 91776-1724

(lowgo.dean@gmail.com)
Low, Dean (via email)
3 Panther Creek Ct.
Henderson, NV 89052-

Attn: Manoucher Sarbaz
Lucerne Valley Partners
9903 Santa Monica Blvd., PMB #541
Beverly Hills, CA 90212-1671

Attn: Nancy Lan
Lake Waikiki
230 Hillcrest Drive
La Puente, CA 91744-4816

(jlangley@kurschgroup.com)
Langley, James (via email)
12277 Apple Valley Road, Ste. #120
Apple Valley, CA 92308-1701

Lawson, Ernest and Barbara
20277 Rock Springs Road
Apple Valley, CA 92308-8740

Attn: Sepoong & Woo Poong Lee
Lee, et al., Sepoong and Woo Poong
#6 Ensueno East
Irvine, CA 92620-

Lenhart, Ronald and Toni
4474 W. Cheyenne Drive
Eloy, AZ 85131-3410

Attn: Eric Larsen
(eric.larsen@libertyutilities.com;
tony.pena@libertyutilities.com)
Liberty Utilities (Apple Valley Ranchos
Water) Corp. (via email)
P. O. Box 7005
Apple Valley, CA 92307

Attn: Neal Davies (ndavies@terra-gen.com;
dkelly@terra-gen.com)
Lockhart Land Holding, LLC (via email)
43880 Harper Lake Road
Hinkley, CA 92347-

Lua, Michael T. and Donna S.
18838 Aldridge Place
Rowland Heights, CA 91748-4890

Attn: Marian Walent
(LVVMC677@gmail.com)
Lucerne Vista Mutual Water Company (via
email)
P. O. Box 677
Lucerne Valley, CA 92356-0677

Attn: c/o J.C. UPMC, Inc. Lori Rodgers
(ljm9252@aol.com;
timrohmbuilding@gmail.com)
Lake Wainani Owners Association (via email)
2812 Walnut Avenue, Suite A
Tustin, CA 92780-7053

Attn: Vanessa Laosy
Lavanh, et al.
18203 Yucca St.
Hesperia, CA 92345-

Attn: Anna K. Lee (aklee219@gmail.com)
Lee, Anna K. and Eshban K. (via email)
10979 Satsuma St
Loma Linda, CA 92354-6113

Lee, Vin Jang T.
42727 Holcomb Trl
Newberry Springs, CA 92365

Attn: Brad Francke
LHC Alligator, LLC
P. O. Box 670
Upland, CA 91785-0670

Attn: James Lin
Lin, Kuan Jung and Chung, Der-Bing
2026 Turnball Canyon
Hacienda Heights, CA 91745-

Attn: Patricia Miranda
Lopez, Baltazar
12318 Post Office Rd
Lucerne Valley, CA 92356-

Attn: Gwen L. Bedics
Lucerne Valley Mutual Water Company
P. O. Box 1311
Lucerne Valley, CA 92356

Attn: Eugene R. & Vickie R. Bird
M Bird Construction
1613 State Street, Ste. 10
Barstow, CA 92311-4162

Mojave Basin Area Watermaster Service List as of September 30, 2024

Attn: Maria Martinez
M.B. Landscaping and Nursery, Inc.
6831 Lime Avenue
Long Beach, CA 90805-1423

Attn: Robert Saidi
Mahjoubi, Afsar S.
46622 Fairview Road
Newberry Springs, CA 92365

Attn: Jimmy Berry
Manning, Sharon S.
19332 Balan Road
Rowland Heights, CA 91748-4017

Attn: Allen Marcroft
Marcroft, James A. and Joan
P. O. Box 519
Newberry Springs, CA 92365

Attn: James M. Hansen, Jr. (gm@mrcwd.org;
gmmrcwd@gmail.com)
Mariana Rancho County Water District (via
email)
9600 Manzanita Street
Apple Valley, CA 92308-8605

Marshall, Charles
32455 Lakeview Road
Newberry Springs, CA 92365-9482

Martin, Michael D. and Arlene D.
32942 Paseo Mira Flores
San Juan Capistrano, CA 92675

Attn: Rod Sexton
McCollum, Charles L.
15074 Spruce St
Hesperia, CA 92345-2950

McKinney, Paula
144 East 72nd
Tacoma, WA 98404-1060

Attn: Olivia L. Mead
Mead Family Trust
31314 Clay River Road
Barstow, CA 92311-2057

Attn: David I. Milbrat
Milbrat, Irving H.
P. O. Box 487
Newberry Springs, CA 92365-0487

Attn: Donna Miller
Miller Living Trust
6124 Parsonage Circle
Milton, FL 32570-8930

Attn: Freddy Garmo (freddy@garmolaw.com)
Minn15 LLC (via email)
5464 Grossmont Center Drive, #300
La Mesa, CA 91942-3035

Attn: David Riddle
(driddle@mitsubishicement.com)
Mitsubishi Cement Corporation (via email)
5808 State Highway 18
Lucerne Valley, CA 92356-8179

Attn: Philip Mizrahie
Mizrahie, et al.
4105 W. Jefferson Blvd.
Los Angeles, CA 90048-

Attn: Thomas A. Hrubik (tahgolf@aol.com)
MLH, LLC (via email)
P. O. Box 2611
Apple Valley, CA 92307-0049

Attn: Sarah Bliss
Mojave Desert Land Trust
60124 29 Palms Highway
Joshua Tree, CA 92252-4130

Attn: Mahnaz Ghamati
(mahnaz.ghamati@atlantica.com)
Mojave Solar, LLC (via email)
42134 Harper Lake Road
Hinkley, CA 92347-9305

Attn: Doug Kerns
(aanabtawi@mojavewater.org)
Mojave Water Agency (via email)
13846 Conference Center Drive
Apple Valley, CA 92307-4377

Attn: Doug Kerns
(tmccarthy@mojavewater.org)
Mojave Water Agency (via email)
13846 Conference Center Drive
Apple Valley, CA 92307-4377

Attn: Manoucher Sarbaz
Monaco Investment Company
9903 Santa Monica Blvd., PMB #541
Beverly Hills, CA 90212-1671

Attn: Ken Elliot (Billie@ElliotPlace.com)
Morris Trust, Julia V. (via email)
7649 Cypress Dr.
Lanexa, VA 23089-9320

Moss, Lawrence W. and Helen J.
38338 Old Woman Springs Road Spc# 56
Lucerne Valley, CA 92356-8116

Attn: Bradford Ray Most
Most Family Trust
39 Sundance Circle
Durango, CO 81303-8131

Attn: Dennis Hills
Mulligan, Robert and Inez
35575 Jakobi Street
Saint Helens, OR 97051-1194

Murphy, Jean
46126 Old National Trails Highway
Newberry Springs, CA 92365-9025

(z.music5909@gmail.com;
zajomusic@gmail.com)
Music, Zajo (via email)
43830 Cottonwood Rd
Newberry Springs, CA 92365-8510

Attn: James Hansen
(gm@marianaranchoswd.org)
Navajo Mutual Water Company (via email)
21724 Hercules St.
Apple Valley, CA 92308-8490

Attn: Billy Liang (flossdaily@hotmail.com;
asaliking@yahoo.com)
New Springs Limited Partnership (via email)
4192 Biscayne St.
Chino, CA 91710-3196

Attn: Jodi Howard
Newberry Community Services District
P. O. Box 220
Newberry Springs, CA 92365-0220

Mojave Basin Area Watermaster Service List as of September 30, 2024

Attn: Jeff Gaastra (jeffgaastra@gmail.com)
Newberry Springs Recreational Lakes
Association (via email)
32935 Dune Road, Space 10
Newberry Springs, CA 92365-

Attn: Mary Ann Norris
Norris Trust, Mary Ann
29611 Exeter Street
Lucerne Valley, CA 92356-8261

Attn: Kenton Eatherton
(keatherton@verizon.net)
NSSLC, Inc. (via email)
9876 Moon River Circle
Fountain Valley, CA 92708-7312

Núñez, Luis Segundo
9154 Golden Seal Court
Hesperia, CA 92345-0197

Attn: Pearl or Gail Nunn
Nunn Family Trust
P. O. Box 545
Apple Valley, CA 92307-0010

Attn: Jeff Gaastra (jeffgaastra@gmail.com;
andy@seesmachine.com;
bbswift4044@cox.net)
O. F. D. L., Inc. (via email)
32935 Dune Road, #10
Newberry Springs, CA 92365-9175

Attn: Chun Soo Ahn
(chunsooahn@naver.com)
Oasis World Mission (via email)
P. O. Box 45
Apple Valley, CA 92307-0001

Attn: Kody Tompkins
(ktompkins@barstowca.org)
Odessa Water District (via email)
220 E. Mountain View Street, Suite A
Barstow, CA 92311-2888

Attn: Dorothy Ohai
Ohai, Reynolds and Dorothy
13450 Monte Vista
Chino, CA 91710-5149

Attn: Craig Maetzold
(craig.maetzold@omya.com)
Omya California, Inc. (via email)
7225 Crystal Creek Rd
Lucerne Valley, CA 92356-8646

Attn: John P. Oostdam
Oostdam Family Trust, John P. and Margie K.
24953 Three Springs Road
Hemet, CA 92545-2246

Attn: Nick Higgs
Oro Grande School District
P. O. Box 386
Oro Grande, CA 92368-0386

Attn: Taghi Shoraka
P and H Engineering and Development
Corporation
1423 South Beverly Glen Blvd. Apt. A
Los Angeles, CA 90024-6171

Attn: Jessica Bails (J4Dx@pge.com)
Pacific Gas and Electric Company (via email)
22999 Community Blvd.
Hinkley, CA 92347-9592

Pak, Kae Soo and Myong Hui Kang
P. O. Box 1835
Lucerne Valley, CA 92356-1835

Patino, José
3914 W. 105th Street
Inglewood, CA 90303-1815

(wndrvr@aol.com)
Paustell, Joan Beinschroth (via email)
10275 Mockingbird Ave.
Apple Valley, CA 92308-8303

Pearce, Craig L.
127 Columbus Dr
Punxsutawney, PA 15767-1270

Perko, Bert K.
P. O. Box 762
Yermo, CA 92398-0762

Pettigrew, Dan
285 N Old Hill Road
Fallbrook, CA 92028-2571

Attn: Sean Wright (swright@pphcsd.org;
dbartz@pphcsd.org; llowrance@pphcsd.org)
Phelan Piñon Hills Community Services
District (via email)
4176 Warbler Road
Phelan, CA 92371-8819

Attn: John Poland
Poland, John R. and Kathleen A.
5511 Tenderfoot Drive
Fontana, CA 92336-1156

Polich, Donna
75 3rd Avenue #4
Chula Vista, CA 91910-1714

Porter, Timothy M.
34673 Little Dirt Road
Newberry Springs, CA 92365-9646

Attn: Carin McKay
Precision Investments Services, LLC
791 Price Street, #160
Pismo Beach, CA 93449-2529

Price, Donald and Ruth
933 E. Virginia Way
Barstow, CA 92311-4027

Pruett, Andrea
P. O. Box 37
Newberry Springs, CA 92365

(s_quakenbush@yahoo.com)
Quakenbush, Samuel R. (via email)
236 Iris Drive
Martinsburg, WV 25404-1338

Attn: Ron Herrmann
Quiros, Fransisco J. and Herrmann, Ronald
35969 Newberry Rd
Newberry Springs, CA 92365-9438

Attn: Elizabeth Murena
(waterboy7F8@msn.com; etminav@aol.com)
Rancheritos Mutual Water Company (via
email)
P. O. Box 348
Apple Valley, CA 92307

Mojave Basin Area Watermaster Service List as of September 30, 2024

Reed, Mike
9864 Donaldson Road
Lucerne Valley, CA 92356-8105

Attn: Brian C. Vail (bvail@river-west.com)
Reido Farms, LLC (via email)
2410 Fair Oaks Blvd., Suite 110
Sacramento, CA 95825-7666

(LucerneJujubeFarm@hotmail.com)
Rhee, Andrew N. (via email)
11717 Fairlane Rd, #989
Lucerne Valley, CA 92356-8829

Attn: Kelly Rice
Rice, Henry C. and Diana
31823 Fort Cady Rd.
Newberry Springs, CA 92365-

Attn: Ian Bryant
Rim Properties, LLC
15434 Sequoia Road
Hesperia, CA 92345-1667

Attn: Josie Rios
Rios, Mariano V.
P. O. Box 1864
Barstow, CA 92312-1864

Rivero, Fidel V.
612 Wellesley Drive
Corona, CA 92879-0825

(RayRizvi@Yahoo.com)
Rizvi, S.R Ali (via email)
4054 Allyson Terrace
Freemont, CA 94538-4186

Attn: Bill Taylor or Property Mngr
(billt@rrmca.com)
Robertson's Ready Mix (via email)
200 S. Main Street, Suite 200
Corona, CA 92882-2212

Attn: Susan Sommers (sommerssqz@aol.com)
Rossi Family Trust, James Lawrence Rossi
and Naomi (via email)
P. O. Box 120
Templeton, CA 93465-0120

Attn: Robert Vega
Royal Way
2632 Wilshire Blvd., #480
Santa Monica, CA 90403-4623

Attn: Sam Marich
Rue Ranch, Inc.
P. O. Box 133109
Big Bear Lake, CA 92315-8915

Attn: Dale W. Ruisch
Ruisch Trust, Dale W. and Nellie H.
10807 Green Valley Road
Apple Valley, CA 92308-3690

Attn: Sherwin Shoraka
S and B Brothers, LLC
1423 S. Beverly Glen Blvd., Ste. A
Los Angeles, CA 90024-6171

Attn: Jafar Rashid
(jr123realestate@gmail.com)
S and E 786 Enterprises, LLC (via email)
3300 S. La Cienega Blvd.
Los Angeles, CA 90016-3115

Attn: Sara Fortuna (sarajfortuna@gmail.com;
fourteengkids@aol.com)
Saba Family Trust dated July 24, 2018 (via
email)
212 Avenida Barcelona
San Clemente, CA 92672-5468

Attn: Kanoe Barker
(kanoebarker@yahoo.com)
Sagabean-Barker, Kanoelokelani L. (via
email)
42224 Valley Center Rd
Newberry Springs, CA 92365

(BILLU711@Yahoo.com)
Samra, Jagtar S. (via email)
10415 Edgebrook Way
Northridge, CA 91326-3952

San Bernardino Co Barstow - Daggett Airport
268 W. Hospitality Lane, Suite 302
San Bernardino, CA 92415-0831

Attn: Jared Beyeler
(waterquality@sdd.sbcounty.gov)
San Bernardino County - High Desert
Detention Center (via email)
222 W. Hospitality Lane, 2nd Floor - SDW
San Bernardino, CA 92415-0415

Attn: Trevor Leja
(trevor.leja@sdd.sbcounty.gov)
San Bernardino County Service Area 29 (via
email)
222 W. Hospitality Lane, 2nd Floor (Spec
San Bernardino, CA 92415-0450

Attn: Jared Beyeler
(ssamaras@sdd.sbcounty.gov;
jbeyeler@sdd.sbcounty.gov;
waterquality@sdd.sbcounty.gov)
San Bernardino County Service Area 42 (via
email)
222 W. Hospitality Lane, 2nd Floor - SDW
San Bernardino, CA 92415-0450

Attn: Jared Beyeler
(ssamaras@sdd.sbcounty.gov;
jbeyeler@sdd.sbcounty.gov;
waterquality@sdd.sbcounty.gov)
San Bernardino County Service Area 64 (via
email)
222 W. Hospitality Lane, 2nd Floor - SDW
San Bernardino, CA 92415-0450

Attn: Jared Beyeler
(ssamaras@sdd.sbcounty.gov;
jbeyeler@sdd.sbcounty.gov;
waterquality@sdd.sbcounty.gov)
San Bernardino County Service Area 70J (via
email)
222 W. Hospitality Lane, 2nd Floor - SDW
San Bernardino, CA 92415-0450

Attn: Michelle Scray (mcsctray@gmail.com)
Scray, Michelle A. Trust (via email)
16869 State Highway 173
Hesperia, CA 92345-9381

Attn: Rod Sexton
Sexton, Rodney A. and Sexton, Derek R.
P.O. Box 155
Rim Forest, CA 92378-

Attn: Joseph Tapia
Sheep Creek Water Company
P. O. Box 291820
Phelan, CA 92329-1820

Mojave Basin Area Watermaster Service List as of September 30, 2024

Sheng, Jen
5349 S Sir Richard Dr
Las Vegas, NV 89110-0100

(gloriasheppard14@gmail.com)
Sheppard, Thomas and Gloria (via email)
33571 Fremont Road
Newberry Springs, CA 92365-9520

Short, Jerome E.
P. O. Box 1104
Barstow, CA 92312-1104

Attn: Carlos Banuelos
(maint@silverlakesassociation.com;
fibarra@silverlakesassociation.com)
Silver Lakes Association (via email)
P. O. Box 179
Helendale, CA 92342-0179

Attn: Nepal Singh (NepalSingh@yahoo.com)
Singh, et al. (via email)
4972 Yearling Avenue
Irvine, CA 92604-2956

Attn: Denise Smith
Smith, Denise dba Amerequine Beauty, Inc
P. O. Box 188
Newberry Springs, CA 92365-0188

Smith, Porter and Anita
8443 Torrell Way
San Diego, CA 92126-1254

Attn: Steve Kim (stevekim1026@gmail.com)
Snowball Development, Inc. (via email)
P. O. Box 2926
Victorville, CA 92393-2926

Attn: Chan Kyun Son
Son's Ranch
P. O. Box 1767
Lucerne Valley, CA 92356

Attn: Erika Clement
(Shannon.Oldenburg@SCE.com;
erika.clement@sce.com)
Southern California Edison Company (via
email)
2 Innovation Way, 2nd Floor
Pomona, CA 91768-2560

Attn: Maria de Lara Cruz
(maria.delaracruz@mineralstech.com)
Specialty Minerals, Inc. (via email)
P. O. Box 558
Lucerne Valley, CA 92356-0558

Sperry, Wesley
P. O. Box 303
Newberry Springs, CA 92365-0303

Spillman, James R. and Nancy J.
12132 Wilshire
Lucerne Valley, CA 92356-8834

Attn: Eric Miller (emiller@svla.com;
alogan@svla.com;)
Spring Valley Lake Association (via email)
SVL Box 7001
Victorville, CA 92395-5107

Attn: Joe Trombino
Spring Valley Lake Country Club
7070 SVL Box
Victorville, CA 92395-5152

Attn: Father Sarapamon
St. Antony Coptic Orthodox Monastery
P. O. Box 100
Barstow, CA 92311-0100

(chiefgs@verizon.net)
Starke, George A. and Jayne E. (via email)
8743 Vivero Street
Rancho Cucamonga, CA 91730-1152

Storm, Randall
51432 130th Street
Byars, OK 74831-7357

Sudmeier, Glenn W.
14253 Highway 138
Hesperia, CA 92345-9422

Attn: Alexandra Lioanag
(sandra@halannagroup.com)
Summit Valley Ranch, LLC (via email)
220 Montgomery Street, Suite PH-10
San Francisco, CA 94104-3433

Attn: Alex Vienna
Sundown Lakes, Inc.
P. O. Box 364
Newberry Springs, CA 92365-0364

Attn: Stephen H. Douglas
(sdouglas@centaurusenergy.com;
mdoublesin@centcap.net;
cre.notices@clenera.com)
Sunray Land Company, LLC (via email)
1717 West Loop South, Suite 1800
Houston, TX 77027-3049

Attn: Venny Vasquez (lbaroldi@synagro.com)
Synagro-WWT, Inc. (dba Nursury Products,
LLC) (via email)
P. O. Box 1439
Helendale, CA 92342-

Attn: Russell Szykowski
Szykowski, Ruth J.
46750 Riverside Rd.
Newberry Springs, CA 92365-9738

Attn: Bill and Elizabeth Tallakson
(billtallakson@sbcglobal.net)
Tallakson Family Revocable Trust (via email)
11100 Alto Drive
Oak View, CA 93022-9535

Tapie, Raymond L.
73270 Desert Greens Dr N
Palm Desert, CA 92260-1206

Taylor, Sharon L.
14141 State Hwy 138
Hesperia, CA 92345-9339

Mojave Basin Area Watermaster Service List as of September 30, 2024

(jerryteisan@gmail.com)
Teisan, Jerry (via email)
P. O. Box 2089
Befair, WA 98528-2089

Attn: Daryl or Lucinda Lazenby
Thayer, Sharon
P. O. Box 845
Luceren Valley, CA 92356-

Attn: Stephen Thomas
Thomas, Stephen and Lori
4890 Topanga Canyon Bl.
Woodland Hills, CA 91364-4229

Attn: Lynnette L. Thompson
Thompson Living Trust, James A. and Sula B.
22815 Del Oro Road
Apple Valley, CA 92308

Attn: Rodger Thompson
Thompson Living Trust, R.L. and R.A.
9141 Deep Creek Road
Apple Valley, CA 92308-8351

Thrasher, Gary
14024 Sunflower Lane
Oro Grande, CA 92368-9617

Attn: Doug Heinrichs
Thunderbird County Water District
P. O. Box 1105
Apple Valley, CA 92307-1105

Attn: Jim Hoover
Triple H Partnership
35870 Fir Ave
Yucaipa, CA 92399-9635

Attn: Mike Troeger (mjtroeger@yahoo.com)
Troeger Family Trust, Richard H. (via email)
P. O. Box 24
Wrightwood, CA 92397

Turner, Terry
726 Arthur Lane
Santa Maria, CA, CA 93455-7403

Attn: Aurelio Ibarra (aibarra@up.com;
powen@up.com)
Union Pacific Railroad Company (via email)
HC1 Box 33
Kelso, CA 92309-

(druppall@aicdent.com)
Uppal, Gagan (via email)
220 S Owens Drive
Anaheim, CA 92808-1327

(gagevaage23@gmail.com)
Vaage, Gage V. (via email)
47150 Black Butte Road
Newberry Springs, CA 92365-9698

Vaca, Andy and Teresita S.
5550 Avenue Juan Bautista
Riverside, CA 92509-5613

Attn: Dean Van Bastelaar
Van Bastelaar, Alphonse
45475 Martin Road
Newberry Springs, CA 92365-9625

Attn: Glen and Jennifer Van Dam
(gvandam@verizon.net)
Van Dam Family Trust, Glen and Jennifer (via
email)
3190 Cottonwood Avenue
San Jacinto, CA 92582-4741

Attn: Jacob Bootsma
Van Leeuwen Trust, John A. and Ietie
44128 Silver Valley Road
Newberry Springs, CA 92365-9588

Attn: John Driscoll
Vernola Trust, Pat and Mary Ann
P. O. Box 2190
Temecula, CA 92593-2190

Attn: John Nahlen
Victor Valley Community College District
18422 Bear Valley Road, Bldg 10
Victorville, CA 92395-5850

Attn: Jade Kiphen
Victor Valley Memorial Park
17150 C Street
Victorville, CA 92395-3330

Attn: Arnold Villarreal
(avillarreal@victorvilleca.gov;
ccun@victorvilleca.gov)
Victorville Water District, ID#1 (via email)
P. O. Box 5001
Victorville, CA 92393-5001

Attn: Arnold Villarreal
(avillarreal@victorvilleca.gov;
kmetzler@victorvilleca.gov;
snawaz@victorvilleca.gov)
Victorville Water District, ID#1 (via email)
P. O. Box 5001
Victorville, CA 92393-5001

Attn: Arnold Villarreal
(sashton@victorvilleca.gov;
avillarreal@victorvilleca.gov;
dmathews@victorvilleca.gov)
Victorville Water District, ID#2 (via email)
PO Box 5001
Victorville, CA 92393-5001

Vogler, Albert H.
17612 Danbury Ave.
Hesperia, CA 92345-7073

Attn: Joan Wagner
Wagner Living Trust
22530 Calvert Street
Woodland Hills, CA 91367-1704

Attn: Christian Joseph Wakula
Wakula Family Trust
11741 Ardis Drive
Garden Grove, CA 92841-2423

(Jlow3367@gmail.com)
Wang, Steven (via email)
2551 Paljay Avenue
Rosemead, CA 91770-3204

Mojave Basin Area Watermaster Service List as of September 30, 2024

Ward, Raymond
P. O. Box 358
Newberry Springs, CA 92365-0358

Weems, Lizzie
9157 Veranda Court
Las Vegas, NV 89149-0480

Weeraisinghe, Maithri N.
P. O. Box 487
Barstow, CA 92312-0487

(andrewwerner11@gmail.com)
Werner, Andrew J. (via email)
1718 N Sierra Bonita Ave
Los Angeles, CA 90046-2231

Attn: James Woody
West End Mutual Water Company
P. O. Box 1732
Lucerne Valley, CA 92356

West, Howard and Suzy
9185 Loma Vista Road
Apple Valley, CA 92308-0557

West, Jimmie E.
P. O. Box 98
Oro Grande, CA 92368-0098

Attn: Nick Gatti ()
Western Development and Storage, LLC (via email)
5701 Truxtun Avenue, Ste. 201
Bakersfield, CA 93309-0402

Attn: Chung Cho Gong
Western Horizon Associates, Inc.
P. O. Box 397
Five Points, CA 93624-0397

Attn: Genaro Zapata
Westland Industries, Inc.
520 W. Willow St.
Long Beach, CA 90806-2800

Attn: Thomas G. Ferruzzo
(tferruzzo@ferruzzo.com)
Wet Set, Inc. (via email)
44505 Silver Valley Road, Lot #05
Newberry Springs, CA 92365-9565

Wiener, Melvin and Mariam S.
1626 N. Wilcox Avenue
Los Angeles, CA 90028-6234

Attn: Manoucher Sarbaz
Wilshire Road Partners
9903 Santa Monica Blvd., PMB #541
Beverly Hills, CA 90212-1671

Attn: Connie Tapie
(praisethelord77777@yahoo.com)
Withey, Connie (via email)
P. O. Box 3513
Victorville, CA 92393-3513

Witte, E. Daniel and Marcia
31911 Martino Drive
Daggett, CA 92327-9752

Attn: Mark J. Cluff
WLSR, Inc.
3507 N 307th Drive
Buckeye, AZ 85396-6746

Attn: David A. Worsey
Worsey, Joseph A. and Revae
P. O. Box 422
Newberry Springs, CA 92365-0422

(thechelseaco@yahoo.com)
Yang, Zilan (via email)
428 S. Atlantic Blvd #205
Monterey Park, CA 91754-3228

Attn: Christine M. Carson, Esq.
(ccarson@awattorneys.com)
Aleshire & Wynder, LLP (via email)
3880 Lemon Street
Suite 520
Riverside, CA 92501-

Attn: Robert Hensley, Esq.
(rhensley@awattorneys.com)
Aleshire & Wynder, LLP (via email)
3880 Lemon Street
Suite 520
Riverside, CA 92501-

Attn: Pam Lee, Esq. (plee@awattorneys.com)
Aleshire & Wynder, LLP (via email)
3880 Lemon Street
Suite 520
Riverside, CA 92501-

Attn: Alison Paap (apaap@agloan.com)
American AgCredit (via email)
42429 Winchester Road
Temecula, CA 92590-2504

Attn: Wesley A. Miliband, Esq.
(wes.miliband@mwaterlaw.com)
Atkinson, Andelson, Loya, Ruud & Romo (via email)
2151 River Plaza Drive
Suite 300
Sacramento, CA 95833-

Attn: W.W. Miller, Esq. (bmiller@aalrr.com)
Atkinson, Andelson, Loya-Ruud & Romo (via email)
3612 Mission Inn Avenue, Upper Level
Riverside, CA 92501

Attn: Christopher L. Campbell, Esq.
Baker, Manock & Jensen
5260 N. Palm Avenue, 4th Floor
Fresno, CA 93704-2209

Attn: Aloson Toivola, Esq.
(alison.toivola@bbklaw.com)
Best, Best & Krieger LLP (via email)
300 South Grand Avenue
25th Floor
Los Angeles, CA 90071

Attn: Eric L. Garner, Esq.
(eric.garner@bbklaw.com)
Best, Best & Krieger LLP (via email)
3750 University Avenue
3rd Floor
Riverside, CA 92502-1028

Mojave Basin Area Watermaster Service List as of September 30, 2024

Attn: Piero C. Dallarda, Esq.
(piero.dallarda@bbklaw.com)
Best, Best & Krieger LLP (via email)
P.O. Box 1028
Riverside, CA 92502-

Attn: Christopher Pisano, Esq.
(christopher.pisano@bbklaw.com)
Best, Best & Krieger LLP (via email)
300 South Grand Avenue
25th Floor
Los Angeles, CA 90071

Attn: Stephanie Osler Hastings, Esq.
(SHastings@bhfs.com; mcarlson@bhfs.com)
Brownstein Hyatt Farber Schreck, LLP (via email)
1021 Anacapa Street, 2nd Floor
Santa Barbara, CA 93101-2102

Attn: William J. Brunick, Esq.
(wbrunick@bmklawplc.com)
Brunick, McElhane & Kennedy PLC (via email)
1839 Commercenter West
P.O. Box 13130
San Bernardino, CA 92423-3130

Attn: Terry Caldwell, Esq.
Caldwell & Kennedy
15476 West Sand Street
Victorville, CA 92392

Attn: Stephen Puccini
(stephen.puccini@wildlife.ca.gov)
California Department of Fish and Wildlife
(via email)

Attn: Alexander Devorkin, Esq.
California Department of Transportation
100 South Main Street, Suite 1300
Los Angeles, CA 90012-3702

Attn: Nancy McDonough
California Farm Bureau Federation
2300 River Plaza Drive
Sacramento, CA 95833

Attn: Jeffery L. Caufield, Esq.
(Jeff@caufieldjames.com)
Caufield & James, LLP (via email)
2851 Camino Del Rio South, Suite 410
San Diego, CA 92108-

Attn: Andrew L. Jared, Esq.
(ajared@chwlw.us)
Colantuono, Highsmith & Whatley, PC (via email)
790 E. Colorado Blvd., Suite 850
Pasadena, CA 91101-2109

Attn: Matthew T. Summers, Esq.
(msummers@chwlw.us)
Colantuono, Highsmith & Whatley, PC (via email)
790 E. Colorado Blvd., Suite 850
Pasadena, CA 91101-2109

Attn: Maria Insixiengmay
(Maria.Insxiengmay@cc.sbcounty.gov)
County of San Bernardino, County Counsel
(via email)
385 N. Arrowhead Avenue, 4th Floor
San Bernardino, CA 92415-0140

Attn: Robert E. Dougherty, Esq.
Covington & Crowe
1131 West 6th Street
Suite 300
Ontario, CA 91762

Attn: Ed Dygert, Esq.
Cox, Castle & Nicholson
3121 Michelson Drive, Ste. 200
Irvine, CA 92612-

Attn: Noah GoldenKrasner, Dep
(Noah.GoldenKrasner@doj.ca.gov)
Department of Justice (via email)
300 S. Spring Street, Suite 1700
Los Angeles, CA 90013

Attn: Marilyn Levin, Dep
(Marilyn.Levin@doj.ca.gov)
Department of Justice (via email)
300 S. Spring Street, Suite 1702
Los Angeles, CA 90013

Attn: Diana Carloni, Esq.
(diana@carlonilaw.com)
Diana J. Carloni (via email)
21001 N. Tatum Blvd.
Suite 1630-455
Phoenix, AZ 85050-

Attn: James S. Heiser, Esq.
Ducommun, Inc.
23301 S. Wilmington Avenue
Carson, CA 90745

Attn: Michele Hinton, Ms.
(mhinton@fennemorelaw.com)
Fennemore LLP (via email)
8080 N Palm Ave, Third Floor
Fresno, CA 93711-

Attn: Kelly Ridenour, Ms.
(kridenour@fennemorelaw.com)
Fennemore LLP (via email)
550 East Hospitality Lane
Suite 350
San Bernardino, CA 92408-4206

Attn: Marlene Allen Murray, Esq.
(mallenmurray@fennemorelaw.com)
Fennemore LLP (via email)
550 East Hospitality Lane
Suite 350
San Bernardino, CA 92408-4206

Attn: Derek Hoffman, Esq.
(dhoffman@fennemorelaw.com)
Fennemore LLP (via email)
550 East Hospitality Lane
Suite 350
San Bernardino, CA 92408-4206

Attn: Thomas G. Ferruzzo, Esq.
(tferruzzo@ferruzzo.com)
Ferruzzo & Ferruzzo, LLP (via email)
3737 Birch Street, Suite 400
Newport Beach, CA 92660

Attn: Toby Moore, PhD, PG, CHG
(TobyMoore@gswater.com)
Golden State Water Company (via email)
160 W. Via Verde, Suite 100
San Dimas, CA 91773-

Attn: Andre de Bortnowsky, Esq.
(andre@gblawoffices.com)
Green de Bortnowsky, LLP (via email)
30077 Agoura Court, Suite 210
Agoura Hills, CA 91301-2713

Attn: Michelle McCarron, Esq.
(mmccarron@gdblwoffices.com;
andre@gdblwoffices.com)
Green de Bortnowsky, LLP (via email)
30077 Agoura Court, Suite 210
Agoura Hills, CA 91301-2713

Attn: Calvin R. House, Esq.
Gutierrez, Preciado & House
3020 E. Colorado BLVD
Pasadena, CA 91107-3840

Mojave Basin Area Watermaster Service List as of September 30, 2024

Attn: Curtis Ballantyne, Esq.
Hill, Farrer & Burrill
300 S. Grand Avenue, 37th Floor
1 California Plaza
Los Angeles, CA 90071

Attn: Thomas S. Bunn, Esq.
(TomBunn@lagerlof.com)
Lagerlof, Senecal, Gosney & Kruse, LLP (via email)
301 N. Lake Avenue, 10th Floor
Pasadena, CA 91101-5123

Attn: Robert C. Hawkins, Esq.
Law Offices of Robert C. Hawkins
14 Corporate Plaza, Suite 120
Newport, CA 92660

Attn: Adnan Anabtawi
(aanabtawi@mojavewater.org)
Mojave Water Agency (via email)
13846 Conference Center Drive
Apple Valley, CA 92307

Attn: Betsy Brunswick (bmb7@pge.com)
Pacific Gas and Electric Company (via email)
77 Beale Street, B28P
San Francisco, CA 94105-1814

Attn: Todd O. Maiden, Esq.
(TMaiden@ReedSmith.com)
Reed Smith LLP (via email)
101 Second Street
Suite 1800
San Francisco, CA 94105-

Attn: Randall R. Morrow, Esq.
Semptra Energy Law Department
Office of the General Counsel
555 West Fifth Street, Suite 1400
Los Angeles, CA 90013-1011

Attn: Rick Ewaniszyk, Esq.
The Hegner Law Firm
14350 Civic Drive
Suite 270
Victorville, CA 92392

Attn: Michael Turner, Esq.
(mturner@kasdandclaw.com)
Kasdan, LippSmith Weber Turner, LLP (via email)
19900 MacArthur Blvd., Suite 850
Irvine, CA 92612-

Attn: Peter J. Kiel, Esq.
(pkiel@cawaterlaw.com)
Law Office of Peter Kiel PC (via email)
PO Box 422
Petaluma, CA 94953-0422

Attn: Arthur G. Kidman, Esq.
McCormick, Kidman & Behrens
695 Town Center Drive, Suite 400
Costa Mesa, CA 92626-7187

Attn: Frederic A. Fudacz, Esq.
(ffudacz@nossaman.com)
Nossaman LLP (via email)
777 South Figueroa Street, 34th Floor
Los Angeles, CA 90017-

Attn: Joesfina M. Luna, Esq.
(fluna@redwineandsherrill.com)
Redwine and Sherrill (via email)
3890 Eleventh Street
Suite 207
Riverside, CA 92501-

Attn: James L. Markman, Esq.
Richards, Watson & Gershon
1 Civic Center Circle
P.O. Box 1059
Brea, CA 92822-1059

Attn: Shannon Oldenburg, Esq.
(shannon.oldenburg@sce.com)
Southern California Edison Company
Legal Department (via email)
P.O. Box 800
Rosemead, CA 91770

Attn: Agnes Vander Dussen Koetsier
(beppeau@aol.com)
Vander Dussen Trust, Agnes & Edward (via email)
P.O. Box 5338
Blue Jay, CA 92317-

Attn: Mitchell Kaufman, Esq.
(mitch@kmc LLP.com)
Kaufman McAndrew LLP (via email)
16633 Ventura Blvd., Ste. 500
Encino, CA 91436-1835

Attn: Fred J. Knez, Esq.
Law Offices of Fred J. Knez
6780 Indiana Ave, Ste 150
Riverside, CA 92506-4253

Attn: Jeffrey D Ruesch
(watermaster@mojavewater.org)
Mojave Basin Area Watermaster (via email)
13846 Conference Center Drive
Apple Valley, CA 92307

Attn: Kieth Lemieux
(KLemieux@omlowlaw.com)
Olivarez Madruga Lemieux O'Neill, LLP (via email)
500 South Grand Avenue, 12th Floor
Los Angeles, CA 90071-2609

Attn: Steven B. Abbott, Esq.
(sabbott@redwineandsherrill.com;
fluna@redwineandsherrill.com)
Redwine and Sherrill (via email)
3890 Eleventh Street
Suite 207
Riverside, CA 92501-

Attn: Elizabeth Hanna, Esq.
Rutan & Tucker
P.O. Box 1950
Costa Mesa, CA 92626

Attn: ()
Southern California Gas Company
Transmission Environmental Consultant (via email)

Attn: Robert C. Wagner, P.E.
(rcwagner@wbcorp.com)
Wagner & Bonsignore
Consulting Civil Engineers (via email)
2151 River Plaza Drive, Suite 100
Sacramento, CA 95833-4133